

PRODUCT SPECIFICATION RESOURCE

Contains specifications and test reports for ConduDisc Pro manufactured by SAE Inc.

ConduDisc Pro is designed to be fully compliant with the NESC, CSA Standard C22.2, ESA On. Reg 22/04 and is USDA RUS approved.



CONDU
 **DISC** PRO

saeinc.com
1 877 234 2502 | 705 733 3307
info@saeinc.com



CONDU DISC PRO

Standards Met by Encapsulated Galvanized Steel Grounding Plate	Pg 3
ConduDisc Pro Technical Specification Sheet	Pg 5
ConduDisc Pro Freeze-Thaw Testing Results and Analysis	Pg 7
Resistance to Electrolytic Corrosion: Blackburn GP-100 Copper Grounding Plate, a Galvanized Steel Grounding Plate and the ConduDisc	Pg 15
ConduDisc Pro Compression Testing Results	Pg 33
ConduDisc Pro Permeability Testing Results	Pg 34
ConduDisc Leachate Testing Results	Pg 36
ConduDisc Fault Current Withstand	Pg 38
ConduDisc Engineering Drawing	Pg 49
ConduDisc Pro SDS	Pg 50

Standards Met by Encapsulated Galvanized Steel Grounding Plate

ASTM Standards

1. ASTM A123/A123M: Standard Specification for Zinc (Hot-Dip Galvanized) Coatings on Iron and Steel Products

This specification covers the standard requirements for hot-dip galvanized zinc coatings on iron and steel products made from rolled pressed and forged shapes, castings, plates, bars, and strips. This specification deals with both unfabricated products and fabricated products, for example, assembled steel products, structural steel fabrications, large tubes already bent or welded before galvanizing, and wire work fabricated from uncoated steel wire. Also covered here are steel forgings and iron castings incorporated into pieces fabricated before galvanizing or those too large to be centrifuged (or otherwise handled to remove excess galvanizing bath metal).

2. ASTM A153/A153M: Standard Specification for Zinc Coating (Hot-Dip) on Iron and Steel Hardware

This specification covers standards for zinc coatings applied through hot-drip process on iron and steel hardware. The hot-dip galvanizing process shall form layers of Zn/Fe alloy adhering to the steel surface. This specification is applicable to steel hardware items of Classes A, B, C, and D. The thickness or weight/mass of zinc coating shall conform to specified values for various classes of materials. The coated articles shall be free from uncoated areas, blisters, flux deposits, dross inclusions, and other defects. The coating shall be smooth and reasonable uniform in thickness. Tests shall be performed to determine the minimum coating weight or minimum coating thickness, finish and appearance, embrittlement, adherence, average weight/mass of coating, and average thickness of coating. Guidelines are also given for inspection, rejection and retest, packaging, and certification procedures.

CSA Standards

Galvanized Steel Plate components and assembly procedures follow strict CSA Standards as outlined in CAN/CSA-C22.2 No. 65-13 Section 9.1.10.2 and CAN/CSA-C22.2 No. 41-13 Section 6.10.4.1.

No. 65-13 Section 9.1.10.2 The following hardware shall be used to make the connections mentioned in 9.1.10.1; once the initial assembly is completed, there shall be no subsequent retightening:

- a. A bolt shall be plated steel, SAE Grade 2, UNC thread having a maximum standard diameter compatible with the hole or holes in the connector tang and a minimum standard length allowing at least a 2-thread projection through the nut, and the projection shall not exceed 6.4 mm (1/4 in.) after assembly.
- b. A single flat washer shall be used on each side of the tang-to-tang or tang-to-bus connection. These washers shall be plated steel having an SAE configuration compatible with the diameter of the bolt.
- c. A nut shall be plated steel, and shall have a Class 2B, UNC and a hexagonal configuration.
- d. Clean, dry, nonlubricated screws and bolts and nuts shall be used.
- e. The assembled hardware shall be torqued to the values in Table 24.
(8 N·m for a 1/4" screw or bolt)

No. 41-13 Section 6.10.4.1 A plate electrode shall:

- a. be not less than 6.4 mm (1/4 in) in thickness if of iron or steel, or 1.5 mm (0.06 in) if of nonferrous metal, other than aluminum;
- b. have a total surface area of not less than 0.186 m² (2 ft²);
- c. if provided with a means of connection to the system grounding conductor, have connections that comply with the requirements of Clauses 6.1.3, 7.1, and 7.5; and
- d. shall be marked in accordance with Clause 10.10.

Published Date: November 2022

ConduDisc Pro Technical Specifications

Physical Properties

Property	Typical Value	Unit	Test Method
Physical State	Black Solid		
Odor	None		
Water Permeability	1.72 x 10 ⁻⁷	cm/sec	ASTM D5084 (2.6 psi)
Flammability	No ignition		Exposed to a propane torch (~2000 °C) for 60 seconds
Electrical Corrosion Resistance Copper Steel Galvanized Steel	100 98.09 99.91	%	SAE Inc. Standard 100
Compatibility Copper Steel Galvanized Steel	Yes Yes Yes		SAE Inc. Standard 100
Environmental Impact	Neutral		Ontario Regulation 558/00 (Leachate Testing)
Freeze-thaw Withstand	30	Years	SAE Inc. Standard 102

Mechanical Properties

Property	Typical Value	Unit	Test Method
Elastic Compression 7000 kg 12 000 kg 14 500 kg 16 771 kg	2.2 (4.3) 2.6 (5.1) 3.0 (5.9) 3.1 (6.1)	mm (%) mm (%) mm (%) mm (%)	SAE Inc. Standard 103
Maximum Load Applied	16 771	kg	SAE Inc. Standard 103

Electrical Properties

Property	Typical Value	Unit	Test Method
Resistivity	30.39	$\Omega \cdot \text{cm}$	SAE Inc. Standard 105
Conductivity	0.03	S/cm	SAE Inc. Standard 105

Fault Current Withstand

RS Current (A)	RMS Voltage (kV)	Resistance Before Test (m Ω)	Resistance After Test (m Ω)	Approximate Temperature Rise ($^{\circ}\text{C}$)	Test Duration (milliseconds)
1040	19.5	30.6	20.3	1	508
2520	124.0	55.5	20.2	2	508
3730	239.0	44.9	46.0	13	234
4990	176.0	34.6	7.28	1	508

Leachate (TCLP) Results

Leachate Data (TCLP Procedure) based on Ontario Regulation 558/00

Constituent	ConduDisc Pro TCLP Concentration (mg/L)	USEPA Maximum Contaminant Level (mg/L)
Arsenic	BDL	0.010
Barium	1.490	2.000
Boron	1.067	2.000 *
Chromium	0.026	0.100
Mercury	BDL	0.002
Selenium	0.013	0.050
Silver	BDL	0.100 **
Uranium	BDL	0.030
Fluoride	0.190	2.000 **
Nitrate (as Nitrogen)	BDL	10.000
Nitrite (as Nitrogen)	BDL	1.000
Cyanide	BDL	0.200

BDL means the result is "Below the Detection Level" of the analytical procedure

* No MCL established; value shown is USEPA's Lifetime Drinking Water Health Advisory

** No MCL established; value shown is USEPA's Secondary Drinking Water Standard

Published Date: May 2023

ConduDisc Freeze-Thaw Testing

1. INTRODUCTION

- 1.1 The behaviour of the ConduDisc material under freeze-thaw conditions is analyzed in this report. Due to the uniqueness of the material, a combination of studies and standards for similar materials were used to develop an appropriate test procedure. The test procedure involved the rapid freezing and thawing of samples with varying water and salt-water exposure. The samples were studied over 90 freeze-thaw cycles, which is equivalent to 30 years of freeze-thaw withstand.
- 1.2 The mass results of the 90 freeze-thaw cycles for the ConduDisc indicate that physically none of the samples were adversely affected by freezing. The dry samples and the wet samples all experienced minor fluctuations in their masses during the 90 freeze-thaw cycles however, these were determined not to be a cause for concern since the samples are all within 6 g of the initial mass conditions. The freshwater submerged samples and the saltwater submerged samples all experienced a relatively steady increase in mass as the samples absorbed water. This increase in mass of the submerged samples does not indicate that the samples were adversely affected by the freeze-thaw testing since the samples followed the same trend with no major deviations.
- 1.3 The resistance results of the ConduDisc agree with the mass results that no degradation of the samples occurred. All of the samples either returned to their initial resistance values or became more conductive over the 90 freeze/thaw cycles. Any spikes in the resistance of the dry and soaked/wet samples was during freeze measurements and the resistance always dropped during the subsequent thaw measurement. An increase in the conductivity of the ConduDisc samples after freeze-thaw testing is a very positive outcome and indicates that ConduDisc surround material improves as freeze-thaw cycling occurs.
- 1.4 Both the mass and resistance results strongly indicate that the ConduDisc will continue to perform in situ for at least 30 years with no degradation due to freezing and thawing experienced during winter conditions.

2. TEST SETUP

2.1 Background and Development

- 2.1.1 The freeze-thaw stability testing of any product is a topic of great debate, resulting in varying standards and practices even for commonly tested materials such as concrete. Due to its composition and properties the ConduDisc cannot be closely compared with

other materials that are tested for freeze-thaw stability or withstand. This study aims to estimate the material's freeze-thaw behaviour.

2.1.2 Most existing test methods for building materials were deemed not entirely appropriate for the testing of the ConduDisc material. "Masonry: Research, Application, and Problems" (Grogan and Conway) was used as a starting point for the development of the freeze-thaw testing of the ConduDisc material. According to Grogan and Conway, a realistic freeze-thaw test method includes subjecting samples to 90 freeze-thaw cycles, which equates to 30 years of exposure to an extreme environment. It is also suggested in the same literature that three freeze-thaw cycles is to be the equivalent of one year of natural weathering.

2.2 Experimental Design

2.2.1 The largest factors in freeze-thaw behaviour include freeze-thaw rate and exposure to water. To account for the most extreme cases, samples were frozen and thawed as quickly as possible. The exposure to water was also varied. The conditions for each sample are summarized in Table 1.

Table 1: Test Conditions for ConduDisc Samples

Sample	Condition
1, 2	Dry
3, 4	Soaked in water, removed prior to freeze cycle
5, 6	Completely submerged in freshwater
7, 8	Completely submerged in saltwater

2.2.2 One freeze-thaw cycle in this study was defined as a freeze period for 16 hours +/- 2 hours, a thaw period for 24 hours +/- 2 hours, then samples 3 and 4 were soaked in water for 5 – 7 hours and a new cycle began with the freeze period. Testing of these samples continued until 90 freeze-thaw cycles had been completed, roughly equating to 30 years of exposure to an extreme environment.

3. RESULTS AND ANALYSIS

3.1 Test Conditions

3.1.1 The ConduDisc is expected to face significant exposure to water in-situ. Thus, emphasis is placed on the material's ability to withstand freezing and thawing conditions in water. Samples 1 through 8 were half-disc samples of the ConduDisc material, with approximately 2.0" radius and 1.0" thickness. The initial measurements of each sample are listed in Table 2.

Table 2: Initial Measurements of ConduDisc Samples

Sample	Date	Temperature (°C)	Resistance (Ω)	Mass (g)	System Mass* (g)
1	Oct 16, 2017	15.4	6.0	124	-
2	Oct 16, 2017	15.4	5.7	106	-
3	Oct 16, 2017	15.2	6.0	111	-
4	Oct 16, 2017	15.1	6.1	126	-
5	Oct 16, 2017	15.1	6.0	108	1058
6	Oct 16, 2017	14.4	5.5	126	1058
7	Oct 16, 2017	14.3	5.7	106	1069
8	Oct 16, 2017	14.3	5.4	138	1069

*System mass is defined as the combined mass of the samples, water, and container.

3.1.2 The test procedure was followed immediately after initial measurements were taken. The measurements were taken during each freeze or thaw period and the results were analyzed at the 90-cycle mark.

3.2 Changes in Mass Over 90 Freeze-Thaw Cycles

Figure 1: Changes in Mass of ConduDisc Over 90 Freeze-Thaw Cycles

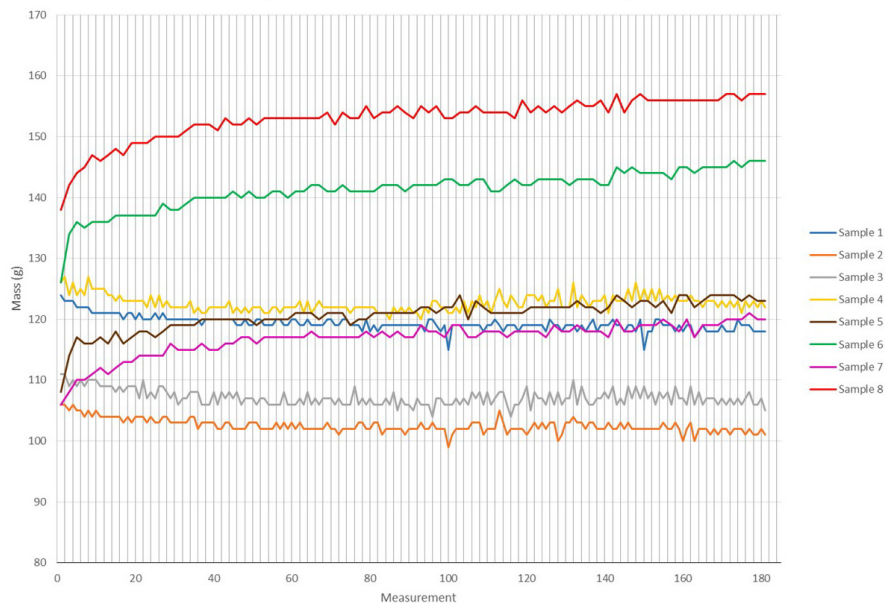

3.2.1 The physical condition of the sample serves as the best indicator of freeze-thaw stability. Ideally, no changes to the appearance of the material should be observed. Cracking and other physical damage should not be observed. The mass of the samples may be used as another indicator of freeze-thaw stability; large deviations from the original mass

of the sample signal material instability. Finally, the samples should not experience extreme deviations in resistance readings. Note that the vertical lines in Figure 1 above indicate data obtained during a freeze period, and the spaces between the vertical lines indicate thaw periods.

- 3.2.2 For the dry samples (1 and 2), the mass did fluctuate on occasion, however these fluctuations were small and were likely due to the inherent scale error, it is accurate to +/- 1 g. The data for these samples indicates that both samples lost a small amount of mass over the 90 cycles, however this loss in mass was only 6 g or 4.8% for sample 1 and 5 g or 4.7% for sample 2 and does not indicate that the samples were adversely affected by freezing.
- 3.2.3 For the wet samples (3 and 4), the mass generally increased when measured after a freeze cycle, since these samples were soaked in water prior to freezing, this indicates that some water is absorbed. The samples expelled the water and returned to approximately their initial mass or lower during thaw periods. There were periods when both samples experienced no change in mass between freeze and thaw cycles which indicated that no water was absorbed or expelled by the samples at this time.
- 3.2.4 The two samples submerged in freshwater (5 and 6), demonstrate a relatively steady increase in mass as the samples absorbed water for the first 15 cycles. During the remaining 75 cycles the samples still demonstrated an increase in mass as the samples absorbed water however the rate of water absorption had significantly decreased, the samples appeared to be approaching constant mass. These samples can only be measured during thaw cycles since they are frozen in their containers during freeze cycles. The increase in the mass of the submerged samples does not indicate that the samples were adversely affected by the freeze-thaw testing since there were no significant deviations from the trend. Both of the samples had absorbed a similar amount of water after the 90 cycles. Sample 5 had increased in mass by 15 g or 13.9% and sample 6 had increased in mass by 20 g or 15.9%.
- 3.2.5 The two samples submerged in saltwater (7 and 8), also demonstrate a relatively steady increase in mass as the samples absorbed water for the first 15 cycles. During the remaining 75 cycles the samples still demonstrated an increase in mass as the samples absorbed water however the rate of water absorption had significantly decreased, the samples appeared to be approaching constant mass. These samples were also only measured during thaw cycles since they were frozen in their containers during freeze cycles. The increase in mass of the samples does not indicate that the samples were adversely affect by the freeze-thaw testing since there were no significant deviations from the trend. Both of the samples had absorbed a similar amount of water after the 90 cycles. Sample 7 had increased in mass by 14 g or 13.2% and sample 8 had increased in mass by 19 g or 13.8%.
- 3.2.6 None of the samples in this study experienced any change in the appearance of the material after 90 freeze-thaw cycles. No cracking or other physical damage to the samples was observed.
- 3.2.7 One month after testing of the ConduDisc samples was completed the samples were analyzed. The dry samples, 1 and 2, had not changed from the final reading after 90 cycles and had lost 6 g (4.8%) and 5 g (4.7%) respectively from their initial mass. The wet samples, 3 and 4, had also only experienced a small change in mass from their

initial values. Sample 3 was still the same value as the final reading after 90 cycles and had lost 6 g (5.4%) from its initial mass. Sample 4 had lost 2 g of water mass since the final reading after 90 cycles and had lost a total of 6 g (4.8%) from its initial value. All of the submerged samples, freshwater and saltwater, had lost all of the water mass they absorbed during the testing and were slightly lower than their initial mass. Sample 5 was 6 g (5.6%) lower than its initial mass, sample 6 was 6 g (4.8%) lower than its initial mass. Sample 7 was 6 g (5.7%) lower than its initial mass, sample 8 was 7 g (5.1%) lower than its initial mass.

3.3 Resistance Measurements Over 90 Freeze-Thaw Cycles

Figure 2: Resistance Trends of the Dry ConduDisc Samples

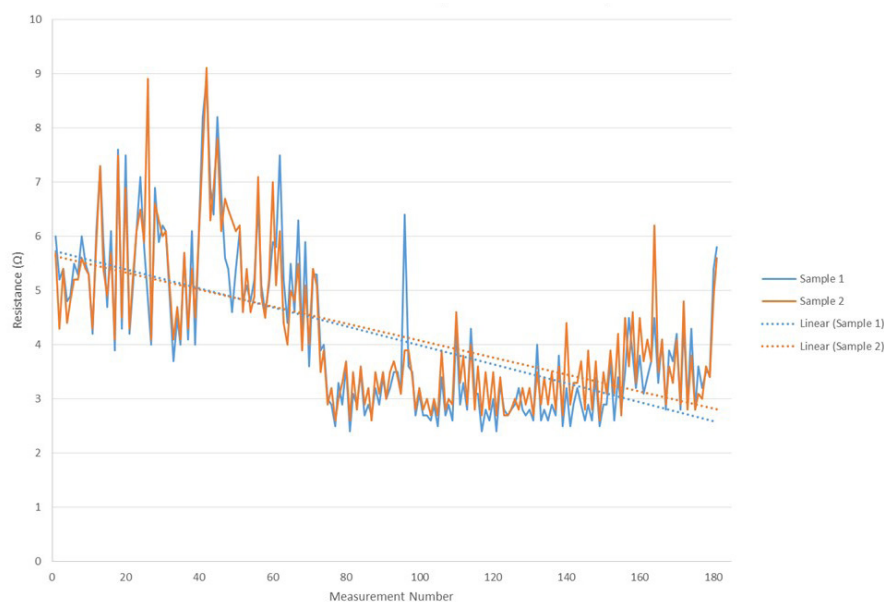

3.3.1 Both dry ConduDisc samples demonstrated very similar resistance trends. There were fluctuations between the resistances of the samples when measured during a freeze cycle or a thaw cycle. In general, both dry ConduDisc samples were more resistive when frozen and less resistive when thawed. After 90 cycles the resistance of both dry ConduDisc samples was slightly lower than their initial values, sample 1 had decreased in resistance by 0.2 ohms (3.3%), and sample 2 had decreased in resistance by 0.1 ohms (1.8%). One month after testing of the samples was complete the resistance was checked. The samples had decreased in resistance significantly, sample 1 was 3.4 ohms (56.7%) lower than the initial resistance and sample 2 was 2.9 ohms (50.9%) lower than the initial resistance. This is a very positive result, indicating that the performance of the samples is not negatively affected, and actually improves when subjected to the freeze-thaw conditions. The less resistive the samples are, the easier the flow of electrons through the material to ground.

Figure 3: Resistance Trends of the Wet ConduDisc Samples

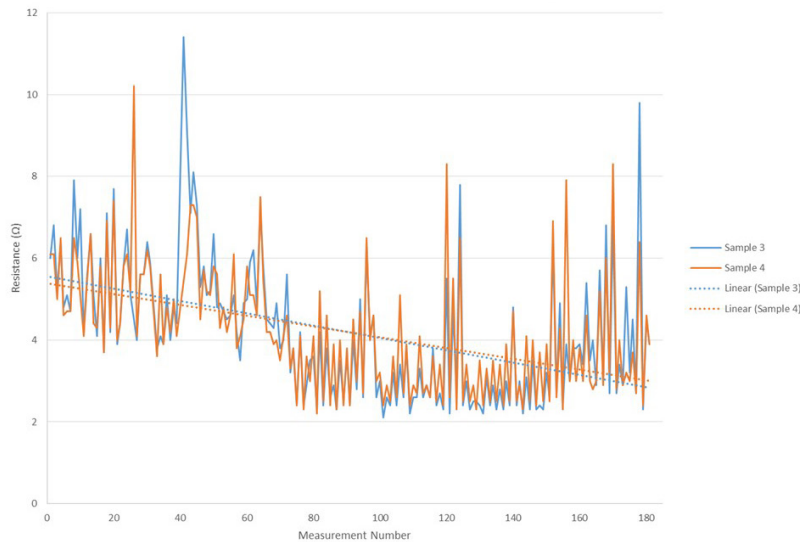

3.3.2 Both wet ConduDisc samples demonstrated very similar resistance trends. There were fluctuations between the resistances of the samples when measured during a freeze cycle or a thaw cycle. In general, both wet ConduDisc samples were more resistive when frozen and less resistive when thawed. After 90 cycles the resistance of both wet ConduDisc samples had decreased by approximately 2.1 ohms (35%). One month after testing of the samples was complete the resistance was checked. The samples further decreased in resistance from their initial values, sample 3 was 3.8 ohms (63.3%) lower than the initial resistance and sample 4 was 4.0 ohms (65.6%) lower than the initial resistance. This is a very positive result, indicating that the performance of the samples improved when subjected to the freeze-thaw conditions. The more conductive the samples are, the easier the electrons flow through the material to ground.

Figure 4: Resistance Trends of the Submerged Freshwater ConduDisc Samples

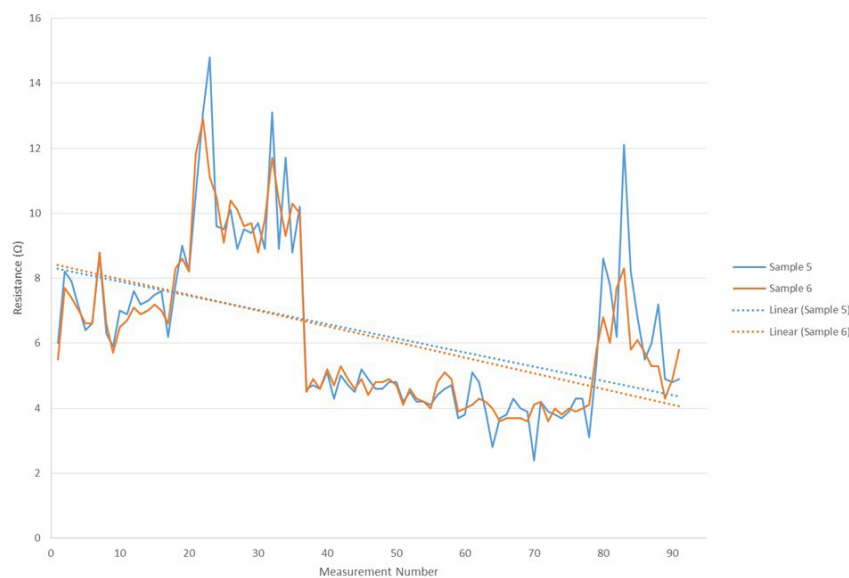

3.3.3 Both ConduDisc samples submerged in freshwater demonstrated fairly similar resistance trends. The values shown in Figure 4 above are the resistance readings taken during the thaw cycles, the samples were frozen in their containers during the freeze cycles and the resistances could not be measured. There were fluctuations in the resistances of the samples however all of the measured values are within +/- 9 ohms of the initial resistance value. After 90 cycles the resistance of ConduDisc sample 5 submerged in freshwater had decreased by 1.1 ohms (18%) and the resistance of sample 6 submerged in freshwater returned to approximately the original value, it increased by only 0.3 ohms (5.4%), which can be attributed to the method used to measure the resistance. One month after testing of the samples was complete the resistance was checked. The samples further decreased in resistance from their initial values, sample 5 was 4.2 ohms (70.0%) lower than the initial resistance and sample 6 was 3.8 ohms (69.1%) lower than the initial resistance. This is a very positive result, indicating that the performance of the samples improved when subjected to the freeze-thaw conditions. The more conductive the samples are, the easier the electrons flow through the material to ground.

Figure 5: Resistance Trends of the Submerged Saltwater ConduDisc Samples

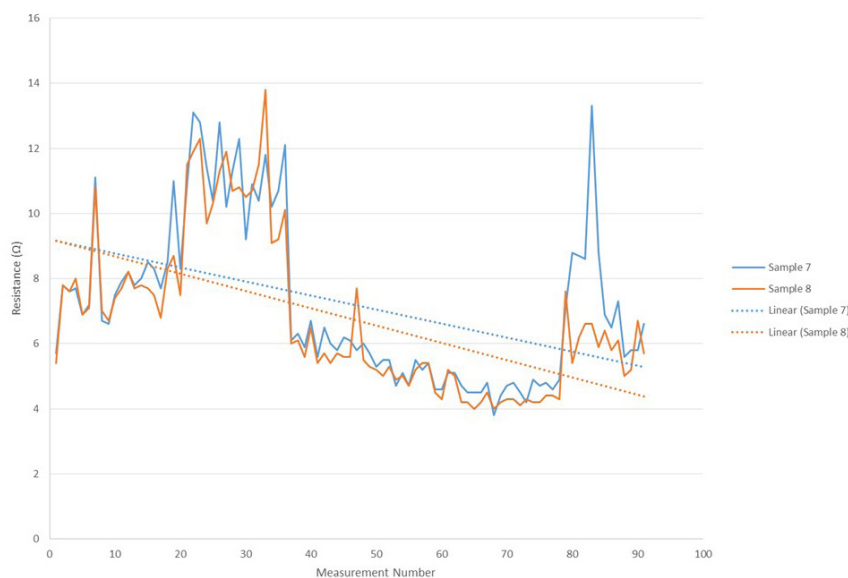

3.3.4 Both ConduDisc samples submerged in saltwater demonstrated fairly similar resistance trends. The values shown in Figure 5 above are the resistance readings taken during the thaw cycles, the samples were frozen in their containers during the freeze cycles and the resistances could not be measured. There were fluctuations in the resistances of the samples however all of the measured values are within +/- 8 ohms of the initial resistance value. After 90 cycles the resistance of both ConduDisc samples submerged in saltwater had returned to roughly the initial resistance value, the small increases in the resistance can be attributed to the method for measuring the resistance. One month after testing of the samples was complete the resistance was checked. The samples had decreased in resistance significantly, sample 7 was 3.9 ohms (68.4%) lower

than the initial resistance and sample 8 was 3.6 ohms (66.7%) lower than the initial resistance. This is a positive result, indicating that the performance of the samples improved when subjected to the freeze-thaw conditions. The more conductive the samples are, the easier the electrons flow through the material to ground.

4. CONCLUSIONS

- 4.1 The results of the 90 freeze-thaw cycles when analyzing the changes in mass of the samples indicate that none of the samples were adversely affected by freezing. The dry samples and the wet samples all experienced minor fluctuations in their masses during the 90 freeze-thaw cycles however, these were determined not to be a cause for concern since the samples are all within 6 g of the initial mass conditions. The freshwater submerged samples and the saltwater submerged samples all experienced a relatively steady increase in mass as the samples absorbed water. This increase in mass of the submerged samples does not indicate that the samples were adversely affected by the freeze-thaw testing since the samples followed the same trend with no major deviations. Also none of the samples experienced any physical deterioration in the form of cracking, or other physical damage.
- 4.2 The resistance results agree with the mass results that no degradation of the samples occurred. All of the samples became more conductive or returned to their initial resistance values over the 90 freeze/thaw cycles which is a very positive result. One month after the completion of the testing all of the samples were significantly more conductive than their initial resistance values. This indicates that the performance of the ConduDisc will improve when subjected to freeze-thaw conditions.
- 4.3 The results of this study strongly indicate that the ConduDisc will perform in situ for at least 30 years with no significant degradation due to freezing and thawing experienced during winter conditions.

Published Date: October 2022

Resistance to Electrolytic Corrosion Comparison: Blackburn GP-100 Copper Grounding Plate, a Galvanized Steel Grounding Plate and the ConduDisc

EXECUTIVE SUMMARY

SAE Inc. has developed the ConduDisc; a conductive grounding plate that dramatically enhances the performance and longevity of utility pole grounding systems by virtually eliminating electrode corrosion and lasting the life of a utility pole. Current competitors to the ConduDisc include the Blackburn GP-100 Grounding Plate and Galvanized Steel Ground Plates. These competitor grounding plates do not provide the same longevity to utility pole grounding systems that the ConduDisc does, making the ConduDisc a superior grounding electrode to the existing grounding electrodes in the market.

In order to compare the longevity of various utility pole grounding plates, an experiment was conducted which measured the corrosion rate of the three different utility pole grounding plates, a Blackburn GP-100 Copper Grounding Plate, a Galvanized Steel Grounding Plate, and a ConduDisc, when buried in damp, salty soil and exposed to a constant low current of 10 milliamps for one year.

At the conclusion of the one year study the Blackburn GP-100 Copper Grounding Plate experienced the most corrosion, with a loss in mass of 74.40%. This left only 25.60% of the grounding plate remaining at the completion of the study and the wire lead was no longer connected to the copper plate indicating that plate would no longer provide effective grounding and had exceeded its service life.

The Galvanized Steel Grounding Plate experienced a loss in mass of 1.25% during the one year study. Additionally, there was a large amount of visible oxidation of the surface of the Galvanized Steel Grounding Plate, the zinc coating on approximately half of the exposed surface had corroded.

In comparison, the ConduDisc, a galvanized steel plate encased in a conductive polymeric surround, experienced no loss of mass during the one-year study. The low permeability of the ConduDisc surround material protected the encased galvanized steel plate from exposure to the moisture and salt in the soil, thus preventing any corrosion from occurring.

Corrosion studies conducted by the National Bureau of Standards, NCEL, and NEGRP measured the corrosion rate of grounding rods exposed to field conditions for up to 10 years. All three studies found that galvanized steel ground rods experience significant corrosion when buried in the earth. Their studies demonstrated that galvanized steel ground rods with the same surface area as the galvanized steel grounding plates in this experiment have a service life of only 10 years.

Though copper is generally considered to be very resistant to corrosion it can corrode when exposed to aggressive soils, stray DC currents, and AC currents. This experiment demonstrated the rapid corrosion of copper when exposed to DC currents and wet/salty soils.

Because lightning protection and grounding systems are ones that installers would prefer to “install and forget”, only 10 or 15 years of performance for a grounding electrode is poor. Constant replacement, including material and labour costs can cause long-term issues and costs for anyone who uses bare metal grounding electrodes.

This experiment demonstrated that using the ConduDisc as a grounding electrode for utility poles and other applications will result in a grounding system that continues to perform long after grounding electrodes such as the Blackburn GP-100 Copper Grounding Plate and Galvanized Steel Grounding Plates have exceeded their service life. Choosing the ConduDisc will ensure that utility poles are grounded for the life of the pole, improving the performance and safety of utility pole grounding systems.

1. INTRODUCTION

- 1.1 SAE Inc. has developed the ConduDisc; a conductive grounding plate that dramatically enhances the performance and longevity of utility pole grounding systems. The ConduDisc grounding plate virtually eliminates electrode corrosion and lasts the life of a utility pole.
- 1.2 The ConduDisc has encased a galvanized steel plate in a conductive polymeric surround material. The steel plate is a mild steel, 0.25 inches (0.64 cm) thick and 13.5 inches (34.29 cm) in diameter. The surface area of this plate is equivalent to the surface area of one 3/4" x 10' ground rod. The plate is then hot dip galvanized according to ASTM A123/A123M and has an average zinc thickness of 3.0 mils. The galvanized steel plate is encased in a conductive polymeric surround material for a product with a final thickness of 2 inches (5.08 cm) and a final diameter of 14.5 inches (36.83 cm). The conductive polymeric surround material is impermeable to water and prevents the corrosion of the encased galvanized steel plate, thus extending the lifetime of the plate. The ConduDisc meets CSA Standards C22.2 No.41-13 Section 6.10.4.1 and No. 65-13 Section 9.1.10.2 and as such meets the ESA Technical Guideline for Section 6 “Approval of Electrical Equipment” with regards to Ontario Regulation 22/04.
- 1.3 The ConduDisc is a superior grounding electrode to the existing grounding electrodes in the market. Current competitors to the ConduDisc include the Blackburn GP-100 Grounding Plate and Galvanized Steel Ground Plates. These competitor grounding plates do not provide the same longevity to utility pole grounding systems that the ConduDisc does.

- 1.4 The Blackburn GP-100 Copper Grounding Plate is a utility pole bottom ground plate for multigrounded neutral construction manufactured by Thomas & Betts (T&B) Corporation, which is now known as ABB Installation Products, Inc. It is made of electrolytic sheet copper and has a built-in high pressure connector for attaching a ground lead. The plate is grooved for trapping moisture. The plate is 7.5 inches (19.05 cm) in diameter and 0.028 inches (0.07 cm) thick.
- 1.5 The galvanized steel grounding plate is made of mild steel, 0.25 inches (0.64 cm) thick and 13.5 inches (34.29 cm) in diameter. The surface area of this plate is equivalent to the surface area of one 3/4" x 10' ground rod. The steel plate is hot dip galvanized according to ASTM A123/A123M and has an average zinc thickness of 3.0 mils.
- 1.6 In order to compare the longevity of these three utility pole grounding plates, the following experiment comparing the electrolytic corrosion resistance of a Blackburn GP-100 copper grounding plate, a galvanized steel grounding plate, and a ConduDisc buried in wet, salty soil over a one-year period was conducted.

2. TEST SETUP

- 2.1 The grounding plates were first weighed using an electronic balance to determine their pre-test weights. Lengths of #8 AWG copper wire with a dual insulation consisting of an inner layer of Kynar (polyvinylidene fluoride) and an outer layer of high molecular weight polyethylene (HMWPE) were attached to each grounding plate. The copper conductor is a bare copper 14 gauge, 7 strand wire. The Kynar layer has a wall thickness of 0.020 inches (0.051 cm) and the HMWPE has a wall thickness of 0.065 inches (0.16 cm).
- 2.2 For the Blackburn GP-100 copper grounding plate the length of dual insulated wire was attached to the plate using the built-in high pressure connector, see Figure 1. For both the galvanized steel grounding plate and the ConduDisc the lengths of dual insulated wire were attached to the plate by first crimping a Thomas & Betts Colour-Keyed Copper Compression Connector (Red Die Code 21) for #8 AWG stranded wire onto the wire and then bolting the connector to the grounding plate using a 1/4" zinc plated bolt, washer, and nut, and tightened to a minimum torque of 8.05 N·m, see Figure 2. The exposed section of copper wire above the crimp connector on the galvanized steel plate grounding electrode was covered with black PVC electrical tape so that any corrosion occurring during the experiment would be focused on the grounding plate itself, not the wire connection. The exposed section of copper wire above the crimp connector on the ConduDisc is encased in the conductive polymeric surround material and protected from corrosion during the experiment.
- 2.3 The inner galvanized steel plate for the ConduDisc was encapsulated in the conductive polymeric surround material and allowed to cure for 6 weeks prior to the start of the experiment. Once the six-week cure of the ConduDisc was complete it was weighed, and the experiment began.
- 2.4 All three grounding plates were placed into containers and surrounded with topsoil. A length of steel rebar was placed into each container approximately 12 inches from the grounding plates. Two liters of water and twenty grams of sodium sulfate was added to each container. The samples were connected in a series circuit to an individual channel of a 60 V power source, to ensure an equal current load. The power source was set to

provide 10 mA of current throughout the duration of the test. The current of 10 mA was chosen in order to replicate the current densities that smaller samples in previous corrosion tests had been exposed to. A schematic of the layout can be seen below in Figure 8.

- 2.5 Five hundred milliliters of water was added to the pail containing the Blackburn GP-100 Copper Grounding Plate twice a week and two liters of water was added to the pails containing the Galvanized Steel Grounding Plate and the ConduDisc twice a week to ensure that the soil remained moist. The different water volumes were due to pail size, the Blackburn GP-100 Copper Grounding Plate was smaller than the other two electrodes and thus placed in a 10 gallon pail filled with soil while the other two samples were each in a quarter of a 2000 L tote and thus had a much larger volume of soil to keep moist. Resistance readings were taken throughout the experiment. The samples were removed from the soil after one year, cleaned, and weighed using an electronic balance.

Figure 1: High Pressure Connector on the Blackburn GP-100 Copper Grounding Plate



Figure 2: Copper Compression Connector Attachment to the Galvanized Steel Grounding Plate (left and middle) and the ConduDisc Inner Plate (right)



Figure 3: Blackburn GP-100 Copper Plate, Prior to the Experiment

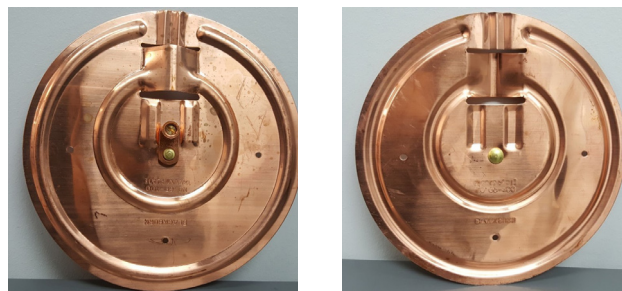

Figure 4: Galvanized Steel Grounding Plate, Prior to the Experiment



Figure 5: Galvanized Steel Grounding Plate to be Encapsulated in ConduDisc Surround Material, Prior to the Experiment

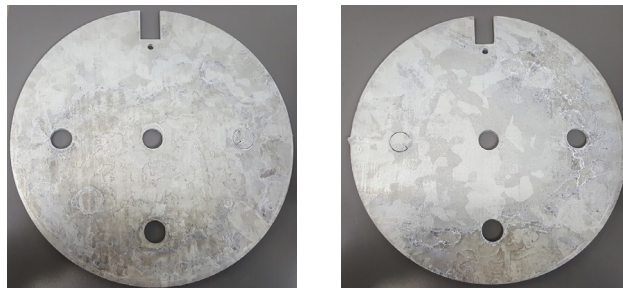

Figure 6: ConduDisc, Prior to the Experiment



Figure 7: Test Setup



Figure 8: Schematics of the Circuit Configuration

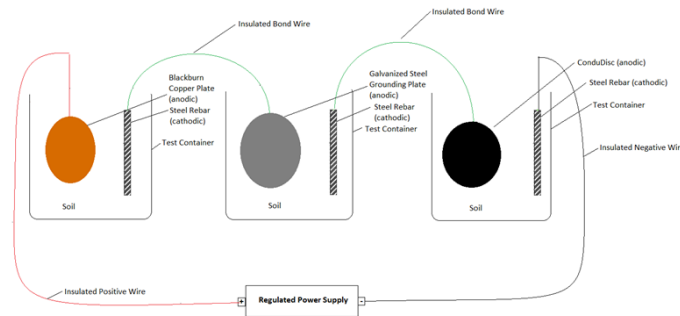

3. RESULTS AND ANALYSIS

3.1 The resistance data for the system was recorded regularly throughout the experiment and can be found in Appendix A. A graph of the resistance of the system throughout the experiment is shown in Figure 9 below. After an initial 8 day period of resistance stabilization, the resistance of the system increased by 33% over the 1-year test. The circuit was connected in series, the amount of current in a series circuit is the same through any component in the circuit because there is only one path for current flow, which means that each of the grounding plates had an equal current of 10 mA running through them for the duration of the test. The voltage of the circuit increased over time, increasing the resistance of the system, as the Blackburn GP-100 Copper Grounding Plate and the Galvanized Steel Grounding Plate oxidized.

Figure 9: Resistance of the System During the 1-Year Corrosion Resistance Test

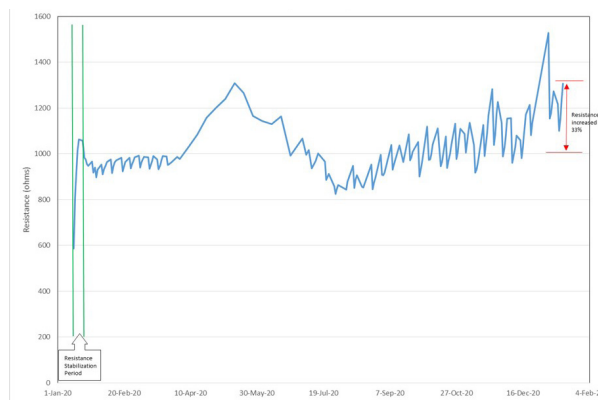

Table 1: Summary of Resistance Data for the System

Date	Voltage (V)	Current (A)	Circuit Resistance (Ω)	Notes
Jan 13, 2020	5.86	0.010	586.00	Test started at 2:35 pm
Jan 21, 2020	9.83	0.010	983.00	End of initial 8 day resistance stabilization
May 13, 2020	13.08	0.010	1308.00	Peak of first spike in resistance
Jan 4, 2021	15.28	0.010	1528.00	Peak of second spike in resistance
Jan 15, 2021	13.07	0.010	1307.00	Test stopped at 2:52 pm

3.2 After one year the experiment was completed and the samples were removed from the soil for analysis. The samples were cleaned and weighed using an electronic balance. As shown in Table 2 and Figures 10, 11, and 12 the Blackburn GP-100 Copper Grounding Plate experienced significant corrosion during the course of the experiment and only 25.6% of the grounding plate remained after being exposed to 10 mA for one year. Additionally shown in Table 2 and Figure 13 the galvanized steel grounding plate corroded during the course of the experiment, losing 1.25% of its mass after being exposed to 10 mA for one year and visibly oxidizing on over half of the exposed surface. In contrast, as shown in Table 2 and Figures 14 and 15, the galvanized steel plate encased in ConduDisc surround material did not visibly oxidize and experienced no change in mass after being exposed to 10 mA for one year. The small gain in mass can be attributed to the small amount of ConduDisc surround material that could not be removed from the galvanized steel plate prior to weighing.

Table 2: Percentage of Mass Consumed from Each Grounding Plate

Sample	Initial Mass (g)	Final Mass (g)	Mass Difference (g)	Percentage Loss (%)
Blackburn GP-100 Copper Grounding Plate	178.72	45.76	- 132.96	- 74.40
Galvanized Steel Grounding Plate	4469	4416	- 53.00	- 1.25
ConduDisc	4510	4513	+ 3.00	+ 0.07

Figure 10: Copper Salt Visible on Top of the Soil in the Blackburn GP-100 Copper Grounding Plate Pail at the Completion of the Experiment



Figure 11: Blackburn GP-100 Copper Grounding Plate, After Experiment

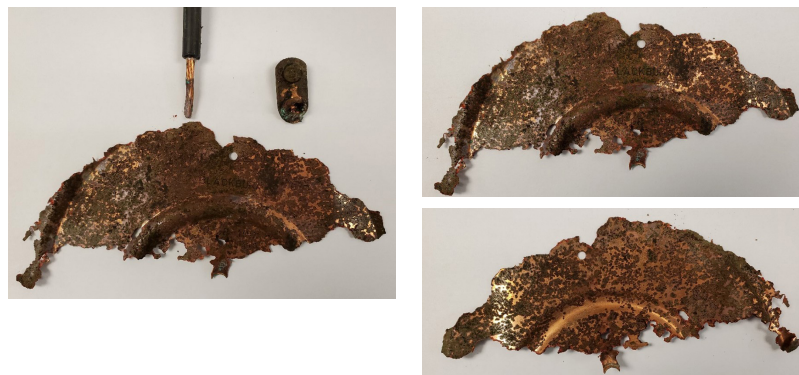

Figure 12: Blackburn GP-100 Copper Grounding Plate with Corroded Pieces Remaining in Soil, After Experiment



Figure 13: Galvanized Steel Grounding Plate, After Experiment



Figure 14: ConduDisc, After Experiment



Figure 15: Galvanized Steel Plate that was Encased in ConduDisc Surround, After Experiment



4. DISCUSSION

- 4.1. The service life of a grounding electrode is determined by its ability to resist corrosion. This experiment found that the only grounding electrode to resist corrosion was the ConduDisc. The Blackburn GP-100 copper grounding plate and the galvanized steel grounding plate were both directly exposed to the soil during the experiment whereas the conductive polymeric jacket that encases the galvanized steel plate in the ConduDisc prevented the galvanized steel plate from being exposed to the soil and any moisture in the soil.
- 4.2. The main factors that dictate the corrosivity of soil are the moisture content, pH level, and chlorides. These soil conditions are affected by additional characteristics such as aeration, temperature, resistivity, and texture of particle size. Oxygen, moisture, and the presence of dissolved salts will lead to corrosion of metal grounding electrodes.
- 4.3. Galvanized steel grounding electrodes are steel grounding electrodes coated with a layer of zinc. Zinc coatings are only resistant to corrosion when stable oxide films form on the surface of the zinc. In the absence of air, such as in buried applications, the stable oxide films will not develop on the surface of the zinc and when moisture is present corrosion of the zinc coating is accelerated. Salts, in particular, are likely to corrode the zinc coating. Thus galvanized steel will experience significant corrosion when buried in soil.
- 4.4. Steel's corrosion rate in soil can vary from 20 μm to 200 μm annually and galvanized coatings can disintegrate at rates starting from less than 5 μm annually in favourable conditions to 25 μm or more annually in very aggressive soils. The American Galvanizer's Association states that a general rule of thumb is that galvanized coatings perform better in sandy soils, and not well in clay-like soils because soil with larger particles wicks moisture away from the surface more quickly so the galvanized coating has less exposure to moisture.
- 4.5. A study conducted by the National Bureau of Standards from 1910 to 1955, found that grounding electrodes coated with 3.9 mils of zinc should only be expected to last for 10 to 15 years reliably in most soil types. The underground corrosion study looked at 36 500 specimens, representing 333 varieties of ferrous, nonferrous, and protective coating materials that were exposed in 128 test locations throughout the United States. The underground exposure testing of hot-dipped zinc coatings on five different base metals began in 1924 and was run for 10 years. The study found that in most soils zinc coatings of 3.5 mils or less were destroyed during the 10 year exposure period, and pitting of the underlying steel occurred. The study additionally showed that a 5.2 mil zinc coating provided adequate protection for 10 to 13 years in all the soils except for those containing high concentrations of soluble salts. The average penetration of zinc in the study was roughly 2.5 mils after 10 years.
- 4.6. A 7-year study in the 1960s conducted by the Naval Civil Engineering Laboratory (NCEL) in cooperation with the National Association of Corrosion Engineers (NACE) tested metal rods for electrical grounding. After 7 years the study was terminated and it was observed that most of the galvanizing on the galvanized steel ground rods had been lost and the steel itself had rusted. The study concluded that zinc and galvanized steel rods did not have the desired corrosion resistance for electrical grounding.

- 4.7 A corrosion study conducted by the National Electrical Grounding Research Project (NEGRP) began in 1992 and compared the long-term performance of different types of grounding electrodes. The rod electrodes at the Pawnee site were excavated in 2003 after 10 years buried in the earth. The $\frac{3}{4}$ " x 10' galvanized steel rods showed significant deterioration of both the galvanized coating and the steel rod itself. The surface area of the galvanized steel plates tested in SAE's experiment, both the galvanized steel plate buried directly in the soil and the ConduDisc's galvanized steel plate encased in a conductive polymeric jacket, have a surface area equivalent to the $\frac{3}{4}$ " x 10' galvanized steel ground rods of the NEGRP study and a zinc layer that is 0.9 mils thinner than the ground rods in the study.
- 4.8 ERICO summarized the results of the above studies on the corrosion of buried galvanized steel grounding electrodes in a 2003 report titled "A Technical Report on the Service Life of Ground Rod Electrodes". ERICO's position is that galvanized steel electrodes are better suited for short-term, non-critical installations and that 3.9 mils of zinc coating is acceptable for infrastructure having a service life of up to 10 years.
- 4.9 Copper is generally considered to be much more impervious to corrosion than steel and galvanized steel, however copper will corrode when it is exposed to certain soils and conditions which cause the protective film on the surface of the metal to be destroyed. These conditions include: abnormally aggressive soils, localized and long-line-type concentration cells created by differences in soil composition, the action of stray direct currents (DC) flowing in the ground, certain conditions created by alternating currents (AC), and galvanic action involving dissimilar metals.
- 4.10 Abnormally aggressive soils include those with elevated sulfate or chloride content combined with considerable moisture content, low resistivity soils, soils that contain large quantities of organic matter and those that support active anaerobic bacteria, and soils containing inorganic acids.
- 4.11 A common sources of stray DC electricity is an impressed-current cathodic protection system (ICCP system). Other potential sources of stray DC current include electric utility high-voltage direct-current (HVDC) transmission systems, DC-powered transit systems, welding facilities, and mining equipment.

5. CONCLUSIONS

- 5.1 This experiment compared the corrosion rate of three different utility pole grounding plates, a Blackburn GP-100 Copper Grounding Plate, a Galvanized Steel Grounding Plate, and a ConduDisc, when buried in damp, salty soil and exposed to a constant low current of 10 milliamps for one year. The Blackburn GP-100 Copper Grounding Plate experienced the most corrosion during the one year study, with a loss in mass of 74.40%. This left only 25.60% of the grounding plate remaining at the completion of the study. The high pressure connector on the grounding plate had partially corroded during the test which indicated that the connection between the wire lead and the grounding plate was no longer intact and that the plate had exceeded its service life.
- 5.2 The Galvanized Steel Grounding Plate experienced a loss in mass of 1.25% during the one year study. Additionally, there was a large amount of visible oxidation of the surface of the Galvanized Steel Grounding Plate, the zinc on approximately half of the exposed surface had corroded.

- 5.3 In comparison the ConduDisc, a galvanized steel plate encased in a conductive polymeric surround experienced no loss of mass during the one-year study. The low permeability of the ConduDisc surround material protected the encased galvanized steel plate from exposure to moisture and salt in the soil, thus preventing any corrosion from occurring.
- 5.4 Corrosion studies conducted by the National Bureau of Standards, NCEL, and NEGRP measured the corrosion rate of grounding rods exposed to field conditions for up to 10 years. All three studies found that galvanized steel ground rods experience significant corrosion when buried in the earth. Galvanized steel ground rods with the same surface area as the galvanized steel grounding plates in this experiment have a service life of only 10 years.
- 5.5 Though copper is generally considered to be very resistant to corrosion it can corrode when exposed to aggressive soils, stray DC currents, and AC currents. This experiment demonstrated the rapid corrosion of copper when exposed to DC currents and wet/salty soil conditions.
- 5.6 Because lightning protection and grounding systems are ones that installers would prefer to “install and forget”, only 10 or 15 years of performance is poor. Constant replacement, including material and labour costs can cause long-term issues and costs for anyone who uses bare metal grounding electrodes.
- 5.7 This experiment demonstrates that using the ConduDisc as a grounding electrode for utility poles and other applications will result in a grounding system that continues to perform long after grounding electrodes such as the Blackburn GP-100 Copper Grounding Plate and Galvanized Steel Grounding Plates have been completely consumed. Choosing the ConduDisc will ensure that utility poles are grounded for the life of the pole, improving the performance and safety of utility pole grounding systems.

Published Date: October 2022

Appendix A

Table 3: Resistance Data for the System (Blackburn GP-100 Copper Grounding Plate, Galvanized Steel Grounding Plate, and the ConduDisc

Date	Voltage (V)	Current (A)	Circuit Resistance (Ω)
Jan 13, 2020	5.86	0.010	586.00
Jan 14, 2020	8.03	0.010	803.00
Jan 15, 2020	9.18	0.010	918.00
Jan 16, 2020	10.15	0.010	1015.00
Jan 17, 2020	10.63	0.010	1063.00
Jan 20, 2020	10.57	0.010	1057.00
Jan 21, 2020	9.83	0.010	983.00
Jan 22, 2020	9.75	0.010	975.00
Jan 23, 2020	9.55	0.010	955.00
Jan 24, 2020	9.47	0.010	947.00
Jan 27, 2020	9.66	0.010	966.00
Jan 28, 2020	9.18	0.010	918.00
Jan 29, 2020	9.41	0.010	941.00
Jan 30, 2020	8.98	0.010	898.00
Jan 31, 2020	9.31	0.010	931.00
Feb 3, 2020	9.53	0.010	953.00
Feb 4, 2020	9.11	0.010	911.00
Feb 5, 2020	9.33	0.010	933.00
Feb 6, 2020	9.5	0.010	950.00
Feb 7, 2020	9.65	0.010	965.00
Feb 10, 2020	9.75	0.010	975.00
Feb 11, 2020	9.16	0.010	916.00
Feb 12, 2020	9.43	0.010	943.00
Feb 13, 2020	9.63	0.010	963.00
Feb 14, 2020	9.72	0.010	972.00
Feb 18, 2020	9.83	0.010	983.00
Feb 19, 2020	9.23	0.010	923.00
Feb 20, 2020	9.44	0.010	944.00
Feb 21, 2020	9.65	0.010	965.00
Feb 24, 2020	9.83	0.010	983.00
Feb 25, 2020	9.37	0.010	937.00

Date	Voltage (V)	Current (A)	Circuit Resistance (Ω)
Feb 26, 2020	9.55	0.010	955.00
Feb 27, 2020	9.69	0.010	969.00
Feb 28, 2020	9.85	0.010	985.00
Mar 2, 2020	9.93	0.010	993.00
Mar 3, 2020	9.41	0.010	941.00
Mar 4, 2020	9.62	0.010	962.00
Mar 5, 2020	9.75	0.010	975.00
Mar 6, 2020	9.87	0.010	987.00
Mar 9, 2020	9.85	0.010	985.00
Mar 10, 2020	9.35	0.010	935.00
Mar 11, 2020	9.52	0.010	952.00
Mar 12, 2020	9.69	0.010	969.00
Mar 13, 2020	9.91	0.010	991.00
Mar 16, 2020	9.75	0.010	975.00
Mar 17, 2020	9.32	0.010	932.00
Mar 18, 2020	9.49	0.010	949.00
Mar 19, 2020	9.72	0.010	972.00
Mar 20, 2020	9.91	0.010	991.00
Mar 23, 2020	9.88	0.010	988.00
Mar 24, 2020	9.51	0.010	951.00
Mar 26, 2020	9.61	0.010	961.00
Mar 31, 2020	9.86	0.010	986.00
Apr 2, 2020	9.77	0.010	977.00
Apr 8, 2020	10.25	0.010	1025.00
Apr 15, 2020	10.83	0.010	1083.00
Apr 22, 2020	11.57	0.010	1157.00
Apr 29, 2020	12.00	0.010	1200.00
May 6, 2020	12.40	0.010	1240.00
May 13, 2020	13.08	0.010	1308.00
May 20, 2020	12.65	0.010	1265.00
May 27, 2020	11.66	0.010	1166.00
Jun 3, 2020	11.43	0.010	1143.00
Jun 10, 2020	11.29	0.010	1129.00

Date	Voltage (V)	Current (A)	Circuit Resistance (Ω)
Jun 17, 2020	11.64	0.010	1164.00
Jun 24, 2020	9.92	0.010	992.00
Jul 3, 2020	10.67	0.010	1067.00
Jul 6, 2020	9.96	0.010	996.00
Jul 8, 2020	10.16	0.010	1016.00
Jul 10, 2020	9.37	0.010	937.00
Jul 13, 2020	9.69	0.010	969.00
Jul 15, 2020	10.02	0.010	1002.00
Jul 20, 2020	9.66	0.010	966.00
Jul 21, 2020	8.86	0.010	886.00
Jul 22, 2020	8.99	0.010	899.00
Jul 23, 2020	9.13	0.010	913.00
Jul 27, 2020	8.59	0.010	859.00
Jul 28, 2020	8.24	0.010	824.00
Jul 29, 2020	8.48	0.010	848.00
Jul 30, 2020	8.64	0.010	864.00
Aug 4, 2020	8.47	0.010	847.00
Aug 5, 2020	8.43	0.010	843.00
Aug 6, 2020	8.78	0.010	878.00
Aug 10, 2020	9.48	0.010	948.00
Aug 11, 2020	8.51	0.010	851.00
Aug 12, 2020	8.88	0.010	888.00
Aug 13, 2020	9.06	0.010	906.00
Aug 17, 2020	8.57	0.010	857.00
Aug 18, 2020	8.52	0.010	852.00
Aug 24, 2020	9.53	0.010	953.00
Aug 25, 2020	8.46	0.010	846.00
Aug 26, 2020	8.73	0.010	873.00
Aug 27, 2020	8.99	0.010	899.00
Aug 31, 2020	9.96	0.010	996.00
Sep 1, 2020	9.09	0.010	909.00
Sep 2, 2020	9.06	0.010	906.00
Sep 3, 2020	9.18	0.010	918.00

Date	Voltage (V)	Current (A)	Circuit Resistance (Ω)
Sep 8, 2020	10.39	0.010	1039.00
Sep 9, 2020	9.31	0.010	931.00
Sep 10, 2020	9.54	0.010	954.00
Sep 14, 2020	10.37	0.010	1037.00
Sep 17, 2020	9.65	0.010	965.00
Sep 21, 2020	10.85	0.010	1085.00
Sep 22, 2020	9.71	0.010	971.00
Sep 23, 2020	9.85	0.010	985.00
Sep 24, 2020	10.09	0.010	1009.00
Sep 28, 2020	10.51	0.010	1051.00
Sep 29, 2020	9.02	0.010	902.00
Sep 30, 2020	9.30	0.010	930.00
Oct 1, 2020	9.62	0.010	962.00
Oct 5, 2020	11.19	0.010	1119.00
Oct 6, 2020	9.73	0.010	973.00
Oct 7, 2020	9.76	0.010	976.00
Oct 8, 2020	10.00	0.010	1000.00
Oct 9, 2020	10.41	0.010	1041.00
Oct 13, 2020	11.11	0.010	1111.00
Oct 15, 2020	9.46	0.010	946.00
Oct 16, 2020	9.64	0.010	964.00
Oct 19, 2020	10.76	0.010	1076.00
Oct 20, 2020	9.39	0.010	939.00
Oct 21, 2020	9.68	0.010	968.00
Oct 22, 2020	10.02	0.010	1002.00
Oct 23, 2020	10.40	0.010	1040.00
Oct 26, 2020	11.31	0.010	1131.00
Oct 27, 2020	9.78	0.010	978.00
Oct 28, 2020	10.08	0.010	1008.00
Oct 29, 2020	10.66	0.010	1066.00
Oct 30, 2020	11.10	0.010	1110.00
Nov 2, 2020	10.87	0.010	1087.00
Nov 3, 2020	10.06	0.010	1006.00

Date	Voltage (V)	Current (A)	Circuit Resistance (Ω)
Nov 4, 2020	10.52	0.010	1052.00
Nov 5, 2020	10.98	0.010	1098.00
Nov 6, 2020	11.35	0.010	1135.00
Nov 9, 2020	10.38	0.010	1038.00
Nov 10, 2020	9.18	0.010	918.00
Nov 11, 2020	9.30	0.010	930.00
Nov 12, 2020	9.59	0.010	959.00
Nov 13, 2020	9.96	0.010	996.00
Nov 16, 2020	11.26	0.010	1126.00
Nov 17, 2020	9.90	0.010	990.00
Nov 18, 2020	10.40	0.010	1040.00
Nov 19, 2020	10.91	0.010	1091.00
Nov 20, 2020	11.67	0.010	1167.00
Nov 23, 2020	12.83	0.010	1283.00
Nov 24, 2020	10.39	0.010	1039.00
Nov 25, 2020	10.85	0.010	1085.00
Nov 26, 2020	11.72	0.010	1172.00
Nov 27, 2020	12.27	0.010	1227.00
Nov 30, 2020	11.35	0.010	1135.00
Dec 1, 2020	9.88	0.010	988.00
Dec 2, 2020	10.29	0.010	1029.00
Dec 3, 2020	10.84	0.010	1084.00
Dec 4, 2020	11.55	0.010	1155.00
Dec 7, 2020	11.56	0.010	1156.00
Dec 8, 2020	9.61	0.010	961.00
Dec 9, 2020	9.91	0.010	991.00
Dec 10, 2020	10.30	0.010	1030.00
Dec 11, 2020	10.80	0.010	1080.00
Dec 14, 2020	10.60	0.010	1060.00
Dec 15, 2020	9.82	0.010	982.00
Dec 16, 2020	10.31	0.010	1031.00
Dec 17, 2020	10.96	0.010	1096.00
Dec 18, 2020	11.72	0.010	1172.00

Date	Voltage (V)	Current (A)	Circuit Resistance (Ω)
Dec 21, 2020	12.14	0.010	1214.00
Dec 22, 2020	10.81	0.010	1081.00
Dec 23, 2020	11.35	0.010	1135.00
Jan 4, 2021	15.28	0.010	1528.00
Jan 5, 2021	11.54	0.010	1154.00
Jan 6, 2021	11.77	0.010	1177.00
Jan 7, 2021	12.25	0.010	1225.00
Jan 8, 2021	12.73	0.010	1273.00
Jan 11, 2021	12.17	0.010	1217.00
Jan 12, 2021	11.00	0.010	1100.00
Jan 13, 2021	11.53	0.010	1153.00
Jan 14, 2021	12.38	0.010	1238.00
Jan 15, 2021	13.07	0.010	1307.00

REFERENCES

1. American Galvanizers Association. How Long Does Hot-Dip Galvanizing Last in Soil?
<https://galvanizeit.org/hot-dip-galvanizing/how-long-does-hdg-last/in-soil/>
2. AZO Materials. (2002, February 26). Galvanized Steel – Underground Corrosion.
<https://www.azom.com/article.aspx?ArticleID=1280>
3. Myers, J.R. & Cohen, A. (1984, August). Conditions Contributing to Underground Copper Corrosion. American Water Works Association Journal.
https://www.copper.org/applications/plumbing/techcorner/pdf/prevent_corrosion_cu_tube_buried_underground_apps.pdf
4. nVent Erico Blog. (2018, September 18). The Pros and Cons of 4 Common Ground Rod Materials.
<https://blog.nvent.com/erico-the-pros-and-cons-of-4-common-ground-rod-materials/>
5. Rempe, Chris. (2003, July 7). A Technical Report on the Service Life of Ground Rod Electrodes. ERICO, Inc.
<https://media.distributordatasolutions.com/erico/2018q4/67603a13811f706951054328a7e308d067cfbcb8.pdf>

Compression Testing of the ConduDisc

In order to determine how the ConduDisc will perform when attached to the bottom of a utility pole in situ, varying loads were applied to full sized ConduDisc samples using an Instron. Our research found that the heaviest wooden utility poles are 125 ft. class H-6 Douglas Fir Poles which weigh 15 480 lbs., or 7022 kg, and the heaviest spun concrete utility poles are 118 ft. class K poles which weigh 24 088 lbs., or 10 926 kg. This does not include the weight of the wires, transformers, and any additional equipment attached to the pole after installation. Table 1 below outlines how much the ConduDisc compressed when subjected to varying loads.

Table 1: ConduDisc Compression Testing

Applied Load (kg)		Applied Pressure		Compression of ConduDisc	
kg	lb	MPa	psi	mm	%
7000	15 432	0.693	100.51	2.2	4.3
12 000	26 456	1.185	171.91	2.6	5.1
14 500	31 967	1.436	208.27	3.0	5.9
16 771	36 975	1.677	241.43	3.1	6.1

As shown in Table 1 the ConduDisc only experienced minimal compression even when subjected to a load over two times the weight of the heaviest wooden utility poles. The compression of the ConduDisc was elastic compression, as once the load was released the samples returned to their original thickness with no deterioration of the sample. None of the ConduDisc samples in this experiment experienced cracking or deterioration of the surround material at any of the loads applied.

Published Date: October 2022

ConduDisc Permeability Testing

Hydraulic Conductivity of Saturated Porous Materials Using a Flexible Wall Permeameter by ASTM D5084 | Constant Volume

Sample Name	ConduDisc
Type	Tube
Permeant Fluid	De-aired distilled water
Orientation	Vertical
Sample Preparation	Placed into permeameter at as received density and moisture content
Assumed Specific Gravity	1.18

Parameter	Initial	Final	Unit
Height	7.13	7.095	inches
Diameter	3.96	3.96	inches
Area	12.34	12.34	inches ²
Volume	87.95	87.65	inches ³
Mass	1639	1672	grams
Bulk Density	70.8	72.55	pcf
Moisture Content	3.8	6	%
Dry Density	68.25	68.55	pcf
Degree of Saturation	58	97	%

B Coefficient Determination

Cell Pressure, psi	89.99	Increased Cell Pressure, psi	94.96	Cell Pressure Increment, psi	4.97
Sample Pressure, psi	87.38	Corresponding Sample Pressure, psi	92.16	Sample Pressure Increment, psi	4.78
				B Coefficient	0.96

Flow Data

Date	Trial #	Pressure, psi		Manometer Readings			Elapsed Time, sec	Gradient	Permeability K, cm/sec	Temp, °C	R _t	Permeability K, @ 20°C, cm/sec
		Cell	Sample	Z ₁	Z ₂	Z ₁ -Z ₂						
May 8 2017	1	90	87.4	23.75	23.5	0.25	43	16.6	1.70E-07	19.5	1.013	1.70E-07
May 8 2017	2	90	87.4	23.75	23.5	0.25	45	16.6	1.83E-07	19.5	1.013	1.84E-07
May 8 2017	3	90	87.4	23.75	23.5	0.25	49	16.6	1.59E-07	19.5	1.013	1.60E-07
May 8 2017	4	90	87.4	23.75	23.5	0.25	51	16.6	1.58E-07	19.5	1.013	1.63E-07

PERMEABILITY AT 20° C: 1.72×10^{-7} cm/sec (@ 2.6 psi effective stress)

These results are the summary of results generated from testing conducted by GeoTesting Express located in Acton, MA. Testing was performed from May 5, 2017 to May 9, 2017.

Published Date: October 2022

ConduDisc Leachate Data

The ConduDisc is environmentally neutral. It is provided as a solid that does not leach, dissolve or migrate into the soil or water. A table of toxicity characteristic leaching procedure (TCLP) results for ConduDisc surround material is included below. The ConduDisc surround material was tested to EPA Standard SW846-6020A. TCLP is a soil sample extraction method for chemical analysis employed as an analytical method to simulate leaching through a landfill. Because the testing methodology is used to determine if a waste is characteristically hazardous, similar conditions are not expected in a typical groundwater environment, and the results overestimate the amount of leaching that would occur.

The TCLP results are compared to the Maximum Contaminant Level (MCL) established by the U.S. Environmental Protection Agency (USEPA) for each constituent in the table below. The MCL is the highest level of a contaminant that is allowed in drinking water. For those constituents detected in the leachate, none exceeded USEPA regulatory standards for drinking water. Additionally, because of TCLP conditions, these constituents would not be expected to present a risk for migration in a typical groundwater environment.

Constituent	ConduDisc TCLP Concentration (mg/L)	USEPA Maximum Contaminant Level (mg/L)
Arsenic	BDL	0.010
Barium	1.490	2.000
Boron	1.067	2.000*
Chromium	0.026	0.100
Mercury	BDL	0.002
Selenium	0.013	0.050
Silver	BDL	0.100**
Uranium	BDL	0.030
Fluoride	0.190	2.000**
Nitrate (as Nitrogen)	BDL	10.000

Constituent	ConduDisc TCLP Concentration (mg/L)	USEPA Maximum Contaminant Level (mg/L)
Nitrite (as Nitrogen)	BDL	1.000
Cyanide	BDL	0.200

BDL means the result is "Below the Detection Level" of the analytical procedure
* No MCL established; value shown is USEPA's Lifetime Drinking Water Health Advisory
** No MCL established; value shown is USEPA's Secondary Drinking Water Standard

Published Date: October 2022

Fault Current Withstand

1. INTRODUCTION

Four ConduDisc samples, manufactured by SAE, Inc., were subjected to short-circuit tests at the High Power Laboratory of Powertech Labs, Inc. The tests were performed for investigative preliminary fault current testing in accordance with the client's requirements.

2. TEST OBJECT INFORMATION

The ConduDisc test objects were identified by the client with the following information:

- Labelled as sample Numbers 1 through 4
- Samples were made using formulation #1117
- Surround encapsulated a 1/8" thick galvanized steel plate
- Lead wire was #2 copper clad steel equivalent to #4 AWG copper wire

3. GENERAL INFORMATION

3.1 Purpose

The purpose of the test was to determine the amount of fault current that the ConduDisc samples can withstand within a 500 millisecond test duration.

3.2 Test Standards / Specifications

There were no specific standards to guide the testing. The tests performed were directed by the client as follows:

- Fault current at levels specified by the client.
- Fault duration of up to 500 milliseconds.

4. FAULT CURRENT TESTING

4.1 General Introduction

Standard	None
Test Date	November 27, 2017

4.2 Environmental Conditions

Ambient temperature	6-10 °C
---------------------	---------

4.3 Test Conditions

Test Voltage	3.7 kV _{rms} phase-to-ground
Test Current Levels	1.04 kA _{rms} to 4.99 kA _{rms}
Phases	1
Test Frequency	60 Hz

The samples were tested using a single-phase circuit as shown in Figure 1. The current level in the tested sample was controlled by adjusting the current-limiting source reactance of the circuit.

4.4 Test Setup

The testing was performed in the High Power Lab test cell with the following configurations:

Tests on Sample Number 1-2, sample setup #1

The test sample assembly consisted of:

- A ½" aluminum plate which acted as a lower grounded electrode
- The ConduDisc placed on top of the electrode
- A fiberglass board placed on top of the ConduDisc
- 2-4 concrete blocks weighing approximately 70-140 lbs. placed on top of the fiberglass board to hold the ConduDisc against the lower electrode
- The assembly was placed on an insulated table for the tests

Current was applied to the ConduDisc through a 43.5 inch long #2 copper-clad steel ground wire which was embedded in the ConduDisc. The configuration of the typical test sample set-up is shown in Figure 2.

Tests on Sample Number 3, sample setup #2

It was found during testing that the #2 copper-clad steel ground wire was insufficient to carry higher fault current levels, and it fused during some of the tests.

The test sample assembly was therefore modified to consist of:

- A ½” aluminum plate which acted as a lower grounded electrode
- The ConduDisc placed on top of the electrode
- A second ½” aluminum plate which acted as an upper energized electrode placed on top of the ConduDisc
- 4 concrete blocks weighing approximately 140 lbs. placed on top of the upper electrode to hold the ConduDisc against the electrodes
- The assembly was placed on an insulated table for the tests

The configuration of the test set-up is shown in Figure 3.

Tests on Sample Number 4, sample setup #3

The test sample assembly consisted of:

- A ½” aluminum plate which acted as a lower grounded electrode
- The ConduDisc placed on top of the electrode
- A second ½” aluminum plate which acted as an upper energized electrode placed on top of the ConduDisc
- A large concrete block weighing approximately 2000 lbs. placed on top of the upper electrode to hold the ConduDisc against the electrodes
- The assembly was placed on an insulated fiberglass board which was placed directly on the concrete floor of the test cell for the tests.

The configuration of the test set-up is shown in Figure 4.

4.5 Requirements

Test samples are required to withstand the applied current for up to 500 milliseconds.

4.6 Results

The following table shows the test data for the tests performed on the tested objects.

Table 1: ConduDisc Fault Current Test Data

Test No.	Test Setup No.	RMS Current (A)	RMS Voltage (kV)	Resistance Before Test (mΩ)	Resistance After Test (mΩ)	Approximate Temperature Rise (°C)	Test Duration (milliseconds)
Sample #1, Test #2	1	1040	19.5	30.6	20.3	1	508
Sample #2, Test #1	1	2520	124	55.5	20.2	2	508

Test No.	Test Setup No.	RMS Current (A)	RMS Voltage (kV)	Resistance Before Test (mΩ)	Resistance After Test (mΩ)	Approximate Temperature Rise (°C)	Test Duration (milliseconds)
Sample #3, Test #2	2	3730	239	44.9	46.0	13	234
Sample #4, Test #1	3	4990	176	34.6	7.28	1	508

The above report is the summary of results generated from testing conducted by Powertech Labs Inc. in Surrey, British Columbia

Report Prepared by
 Erik Groom, P.Eng. | T&D Technology and Testing, Powertech Labs Inc

Report Reviewed by
 Chris Morton, P.Eng. | Technology and Testing, High Power Lab, Powertech Labs Inc

Published Date: November 2022

Powertech

REPORT OF PERFORMANCE

CLIENT / MANUFACTURER	SAE Inc. 19 Churchill Drive Barrie, ON, L4N 8Z5, Canada
TEST OBJECT	ConduDisc Serial number/identification: N/A Description, Condition: Design Investigation
TESTED BY	Powertech Labs Inc. 12388 - 88 th Ave, Surrey, BC Canada V3W 7R7 www.powertechlabs.com
TEST DATE	2017-11-27
TEST SPECIFICATION	Client Specifications

Powertech Labs Inc. does not accept any liability for any damages resulting from the use of this report. The results relate only to the item tested, and it is the responsibility of the manufacturer to maintain conformity of any object having the same designations. Information regarding the estimated measurement uncertainty is available upon request. The test report shall not be reproduced except in full, without written approval of Powertech Labs Inc.

Prepared by:



Erik Groom, P.Eng.
Senior Project Engineer,
T&D Technology and Testing
Powertech Labs Inc.

Reviewed by:



Chris Morton, P.Eng.
Specialist Engineer, Substations
Technology and Testing, High Power Lab
Powertech Labs Inc.

Appendix A | Test Circuit

Figure 1: Test Circuit Schematic

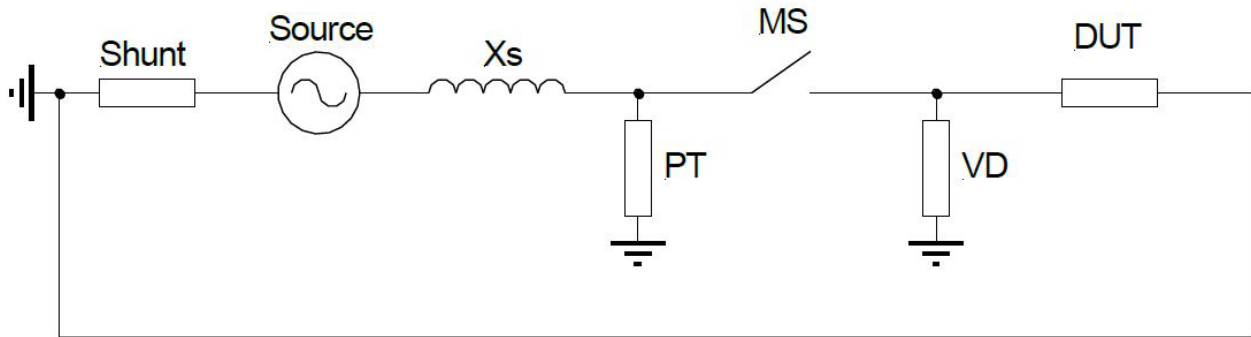

NOTES

- Shunt Current measurement
- Xs Source reactance
- PT Source voltage measurement
- MS Make switch
- VD DUT voltage measurement
- DUT Device under test

Appendix B | Diagrams of the Test Setups

Figure 2: ConduDisc, Test Setup #1

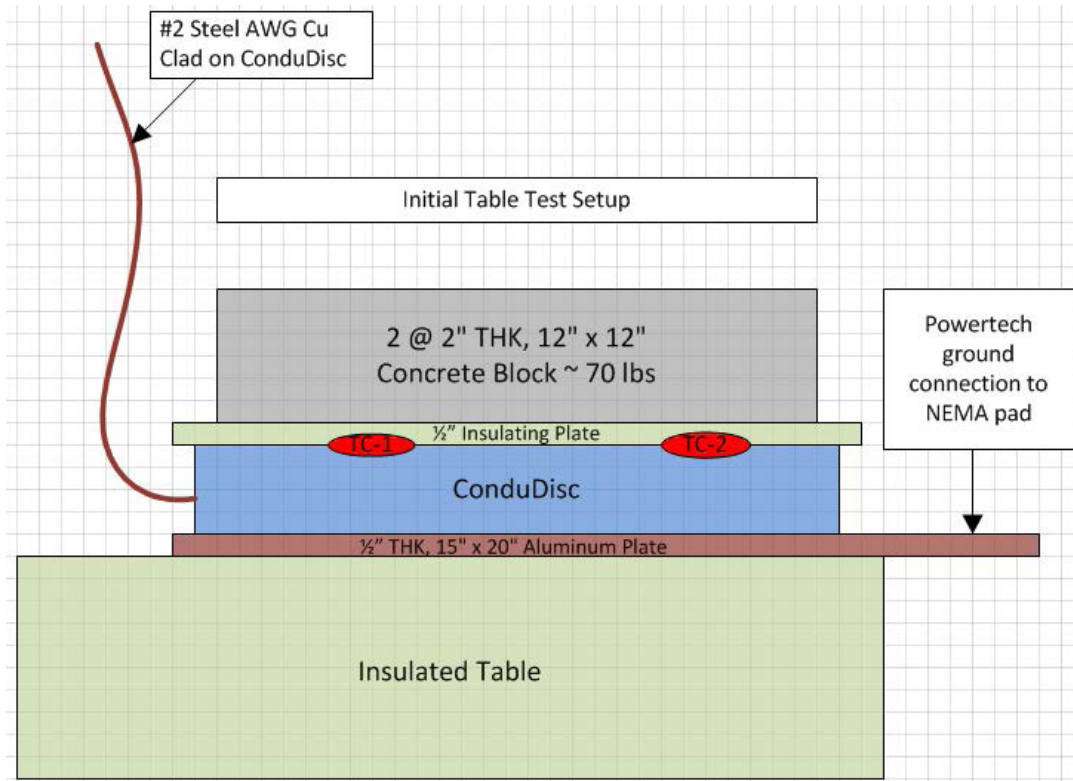

Figure 3: ConduDisc, Test Setup #2

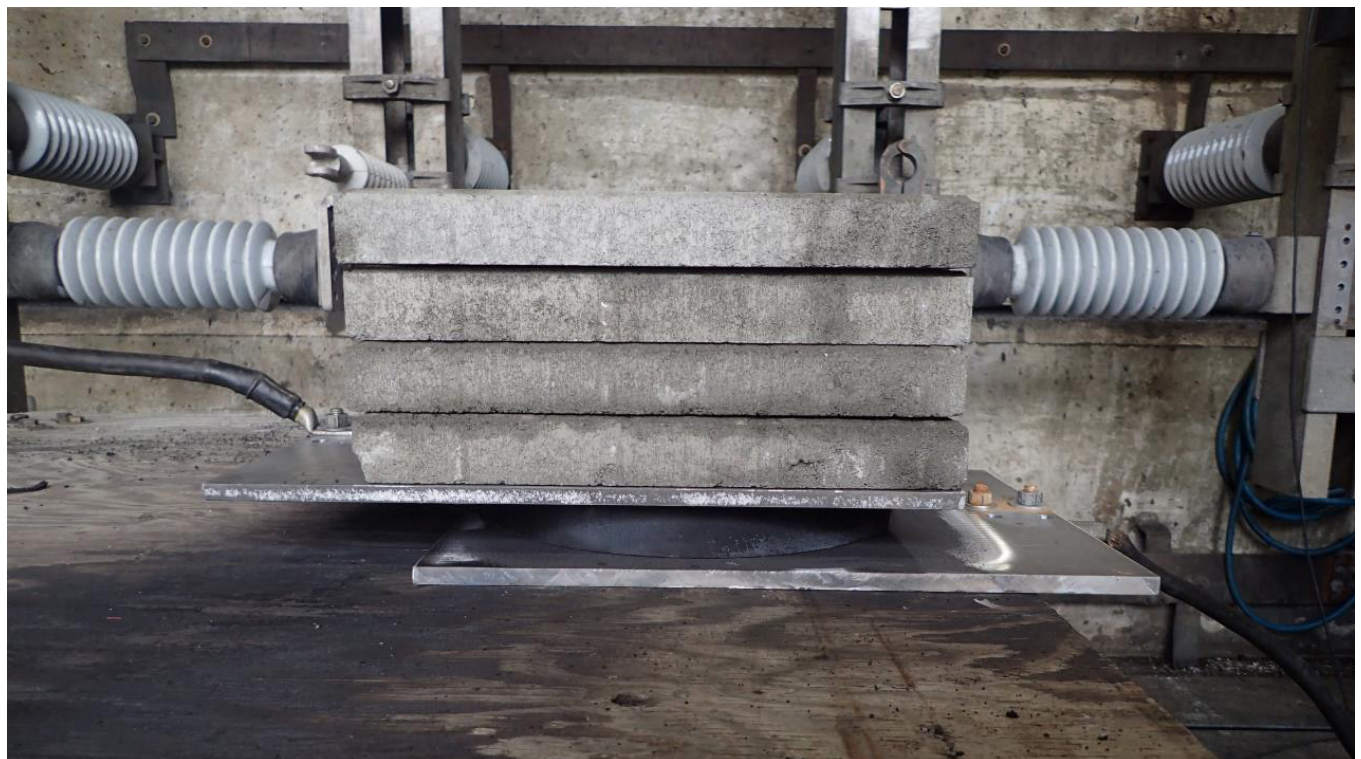
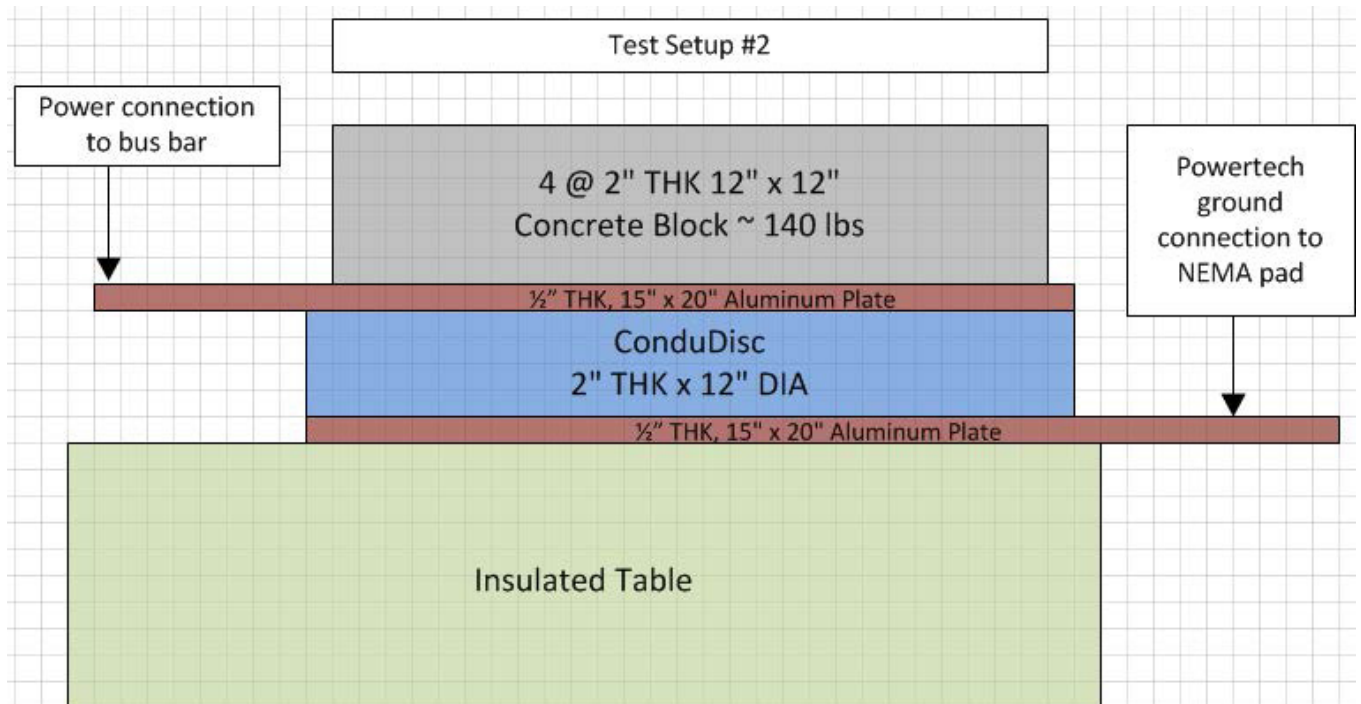
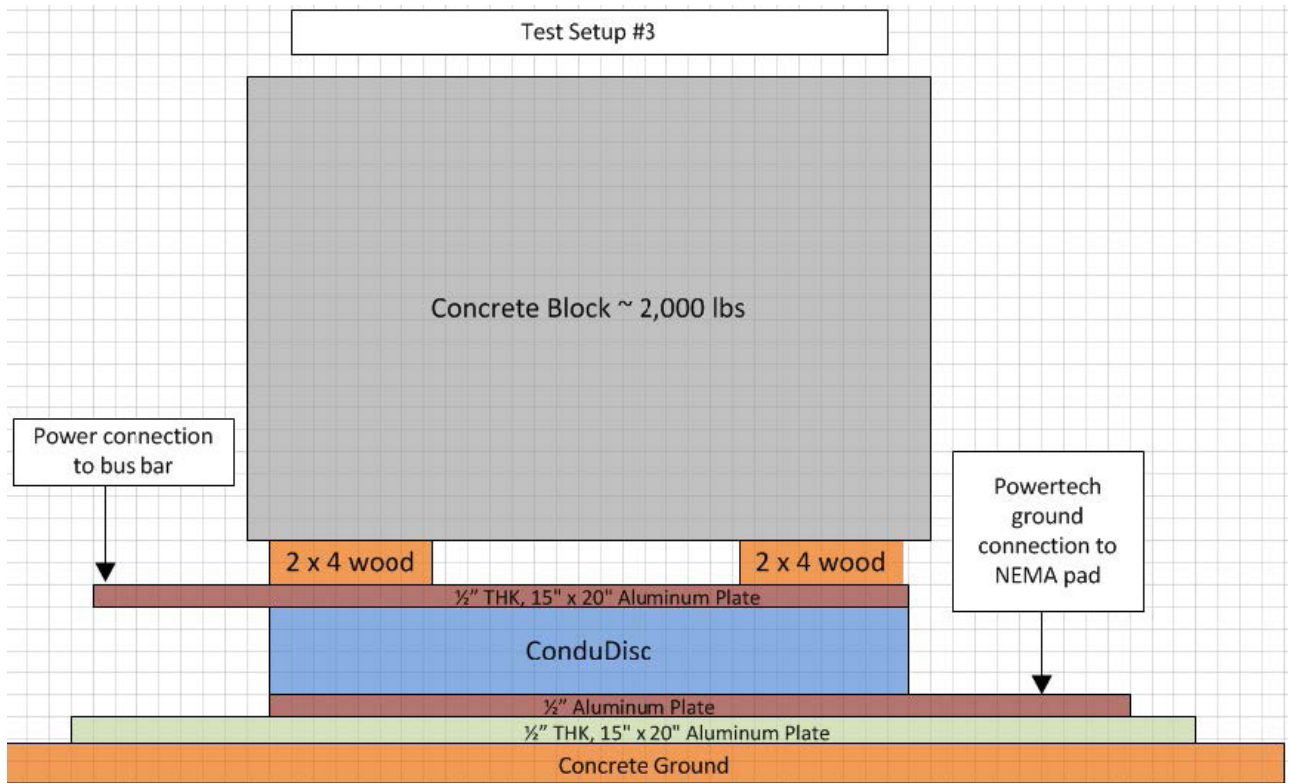
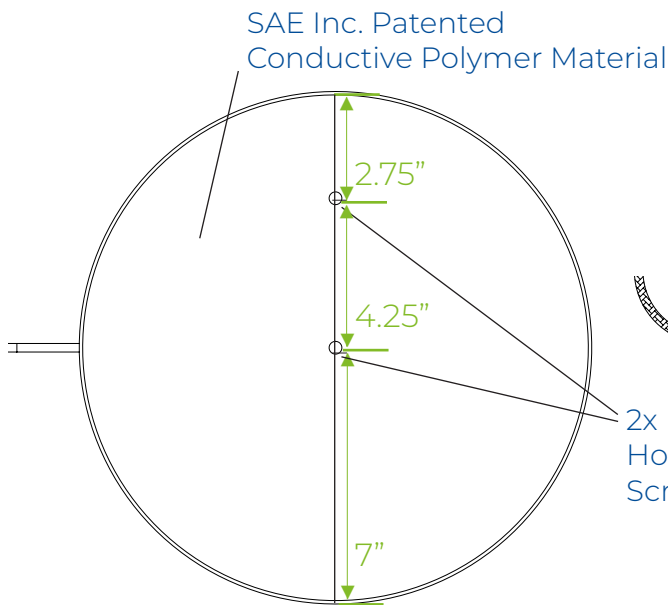

Figure 4: ConduDisc, Test Setup #3



ConduDisc Pro Product Specifications

Top View



Side View

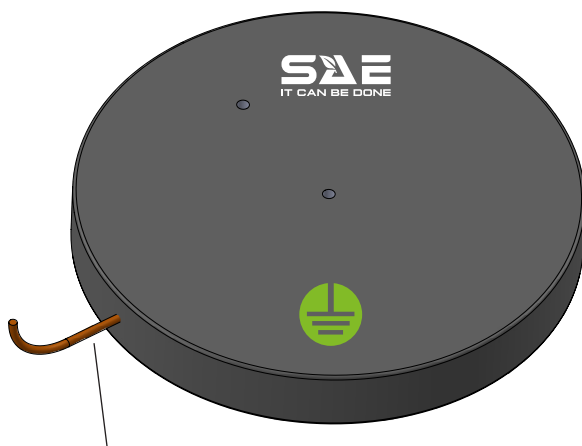
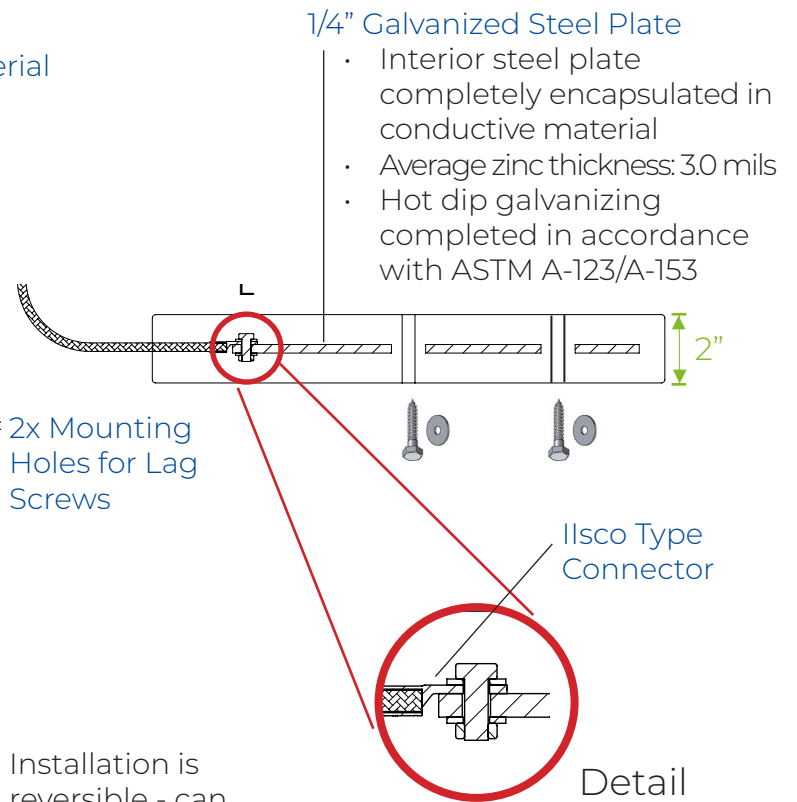

Choice of #6 - 4/0 wire available upon ordering

Not to Scale

Published Date: November 2021

SAFETY DATA SHEET

SECTION 1 | PRODUCT AND COMPANY IDENTIFICATION

PRODUCT

Product Identifier	ConduDisc
Synonyms	ConduDisc, ConduDisc Pro, ConduDisc Flex, ConduDisc Elite
Product Description	Utility Pole and General Use Grounding Plate
Recommended Use	Electrical Grounding Systems

COMPANY IDENTIFICATION

Supplier	SAE Inc 691 Bayview Drive Barrie, Ontario, Canada L4N 9A5 +1 705 733 3307 www.saeinc.com
----------	--

SECTION 2 | HAZARDS IDENTIFICATION

2.1 CLASSIFICATION OF THE MIXTURE

Not classified for physical or health hazards under GHS.

LABELLING

Symbols

None

Signal Word

None

Hazard Statements

Not applicable

Precautionary Statements

Observe good industrial hygiene practices
This product is considered inert and is not hazardous

Trade Secret

A trade secret is being claimed for specific chemical identity and exact percentages

SECTION 3 | COMPOSITION / INFORMATION ON INGREDIENTS

This product is classified as a “manufactured article” and does not constitute a hazardous material in solid form under the definition of the OSHA Hazard Communication Standard (29 CFR 1910.1200) and Section 12 of the Canadian Hazardous Products Act.

saeinc.com

1 877 234 2502 | 705 733 3307
info@saeinc.com



3.1 MIXTURE

Chemical Name	CAS No.	Wt. %
Calcined Petroleum Coke	64743-05-1	40-80
Proprietary Styrene Butadiene Polymer	00000-00-0	1-20
Portland Cement	65997-15-1	1-5
Deionized Water	7732-18-5	1-20
Non-Hazardous Components are Proprietary		

SECTION 4 | FIRST AID MEASURES

4.1 EYE

Rinse or flush exposed eye gently using water. Remove contact lenses, if present, while rinsing. If irritation persists or you are concerned seek medical attention.

4.2 SKIN

Not applicable.

4.3 INHALATION

Not applicable.

4.4 INGESTION

Rinse mouth thoroughly. Do NOT induce vomiting. Do not give anything by mouth to an unconscious person. Seek medical attention if irritation persists or concerned.

4.5 MOST IMPORTANT SYMPTOMS AND EFFECTS, BOTH ACUTE AND DELAYED

Not applicable.

4.6 INDICATION OF ANY IMMEDIATE MEDICAL ATTENTION AND SPECIAL TREATMENT NEEDED

If seeking medical attention provide SDS document to physician. Physician should treat symptomatically.

SECTION 5 | FIRE FIGHTING MEASURES

5.1 FLASHING POINT

Carbonic matter: May burn if exposed to temperatures above 1290 °F (700 °C).

5.2 EXTINGUISHING MEDIA

Use extinguishing media appropriate to the surrounding fire conditions. Water Fog, Dry Chemical, Foam, or Carbon Dioxide.

5.3 SPECIAL HAZARDS

Products of combustion may contain carbon monoxide, carbon dioxide and sulfur dioxide. Firefighters should wear self-contained breathing apparatus and full protective clothing as normal.

5.4 EXPLOSION DATA

Not applicable.

SECTION 6 | ACCIDENTAL RELEASE MEASURES

6.1 PERSONAL PRECAUTIONS, PROTECTIVE EQUIPMENT AND EMERGENCY PROCEDURES

Not applicable.

6.2 ENVIRONMENTAL PRECAUTIONS

Not applicable.

6.3 METHODS AND MATERIALS FOR CONTAINMENT AND CLEANING UP

Use normal housekeeping procedures. Material can be picked up by sweeping, shoveling, or vacuuming.

6.4 REFERENCE TO OTHER SECTIONS

See Section 8 for information on selection of personal protective equipment.

SECTION 7 | HANDLING AND STORAGE

7.1 PRECAUTIONS FOR SAFE HANDLING

The ConduDisc may be damaged by rough handling.

7.2 CONDITIONS FOR SAFE STORAGE

Store in a dry, well-ventilated area, out of the elements. Protect from physical damage or significant water exposure.

SECTION 8 | EXPOSURE CONTROLS / PERSONAL PROTECTION

8.1 CONTROL PARAMETERS

No applicable occupational exposure limits.

8.2 EXPOSURE CONTROLS

8.2.1 Engineering Controls

Handle in accordance with good industrial hygiene and safety practices.

8.2.2 Personal Protection

Workers must comply with the Personal Protective Equipment requirements of the workplace in which this product is handled.

8.2.3 Eye / Face Protection

Not required under normal conditions of use. When installing the ConduDisc wear approved safety glasses.

8.2.4 Skin Protection

Not required under normal conditions of use.

8.2.5 Respiratory Protection

Not required under normal conditions of use.

8.2.6 Other Protection

Perform routine housekeeping. Do not eat, drink, or smoke where this material is handled, stored, and processed. Wash hands thoroughly before eating, drinking, and smoking.

SECTION 9 | PHYSICAL / CHEMICAL PROPERTIES

9.1 INFORMATION ON BASIC PHYSICAL AND CHEMICAL PROPERTIES

Appearance	Solid; black
Odor	Odorless
Odor Threshold	Not applicable
pH	Not applicable
Melting Point / Freezing Point	Not applicable
Initial Boiling Point and Boiling Range	Not applicable
Flash Point	Not applicable
Flammability	Not flammable or combustible
Auto-ignition temperature	>1290 °F, >700 °C
Upper / Lower Flammability or Explosive Limits	Not applicable
Explosive Properties	Not applicable
Oxidizing Properties	Not applicable
Sensitivity to Mechanical Impact	Not applicable
Sensitivity to Static Discharge	Not applicable
Vapor Pressure	Not applicable
Vapor Density	Not applicable
Density	111 lbs/ft ³ , 1778 kg/m ³
Solubility	Not applicable
Partition Coefficient (n-octanol / water)	Not applicable
Decomposition Temperature	>2400 °F, >1316 °C
Viscosity	Not applicable

SECTION 10 | STABILITY AND REACTIVITY

10.1 REACTIVITY

Non-reactive under normal conditions.

10.2 CHEMICAL STABILITY

Stable under normal conditions.

10.3 POSSIBILITY OF HAZARDOUS REACTIONS

None known.

10.4 CONDITIONS TO AVOID

Avoid contact with incompatible materials.

10.5 INCOMPATIBLE MATERIALS

Oxidants - Incompatible with strong oxidizing agents.

10.6 HAZARDOUS DECOMPOSITION PRODUCTS

In normal combustion, carbon oxides and sulfur oxides will be released.

SECTION 11 | TOXICOLOGICAL INFORMATION

11.1 LIKELY ROUTES OF EXPOSURE

The ConduDisc is inert and insoluble, and is not expected to present an ingestion hazard, or other toxicity hazard.

11.2 ACUTE TOXICITY DATA

Not classified.

11.3 CHRONIC TOXICITY

Not applicable

11.3.1 Respiratory and/or Skin Sensitization

Not known to be a respiratory or skin sensitizer.

11.3.2 Germ Cell Mutagenicity

Not available.

11.3.3 Reproductive Effects

Not available.

11.3.4 Developmental Effects

Not available.

11.3.5 Carcinogenicity

Not available.

11.3.6 Interactions with Other Chemicals

Not available.

SECTION 12 | ECOLOGICAL INFORMATION

12.1 TOXICITY

The ConduDisc is inert and insoluble. It does not present any environmental hazards and is not a hazard to aquatic organisms.

12.2 PERSISTENCE AND DEGRADABILITY

Non-biodegradable. The ConduDisc is stable, unreactive in water under ambient conditions, and is insoluble.

12.3 BIOACCUMULATION POTENTIAL

Low bioaccumulation potential as negligible water solubility restricts route of exposure to the aquatic environment.

12.4 MOBILITY IN SOIL

Mobility is insignificant due to negligible water solubility and vapor pressure. May incorporate within soil for extended periods of time.

12.5 OTHER ADVERSE EFFECTS

Not available.

SECTION 13 | DISPOSAL CONSIDERATIONS

13.1 WASTE DISPOSAL

Reuse or recycle packaging whenever possible to minimize the generation of waste. All Federal, Provincial / State, and Local regulations regarding health and pollution must be followed for disposal.

SECTION 14 | TRANSPORT INFORMATION

This product is not classified as a Hazardous Material under U.S. DOT or Canadian TDG regulations. This material is not classified as dangerous under ADR, RID, ADNR, IMDG and IATA regulations.

SECTION 15 | REGULATORY INFORMATION

SAFETY, HEALTH AND ENVIRONMENTAL REGULATIONS / LEGISLATION SPECIFIC FOR THE SUBSTANCE OR MIXTURE

15.1 USA

15.1.1 TSCA Status

Substances are listed on the TSCA inventory or are exempt.

15.2 CANADA

This product has been classified in accordance with the hazard criteria of the *Controlled Products Regulations* and the SDS contains all the information required by the *Controlled Products Regulations*.

15.2.1 NSNR Status

Substances are listed on the DSL or are exempt

15.2.2 RCRA

If discarded in its purchased form, this product would not be a hazardous waste by listing or characteristic. However, under RCRA, it is the responsibility of the product user to determine at the time of disposal, whether a material containing the product or derived from the product should be classified as hazardous waste.

SECTION 16 | OTHER INFORMATION

16.1 REVISION DATE

February 3, 2023

16.2 HMIS HAZARD RATINGS

Health: 0

Flammability: 1

Physical Hazard: 0

16.3 NFPA RATINGS



16.4 ADDITIONAL INFORMATION

This safety data sheet is believed to provide a useful summary of the hazards of ConduDisc as it is commonly used but cannot anticipate and provide all the information that might be needed in every situation. It relates specifically to the product designated and may not be valid for the product when used within any other materials or products or in a particular process.

The information provided herein was believed by SAE Inc. to be accurate at the time of preparation or prepared from sources believed to be reliable. However, no representation, warranty or guarantee, express or implied, is made as to its accuracy, reliability or completeness. It is the responsibility of the user to investigate and understand other pertinent sources of information to comply with all laws and procedures applicable to the safe handling and use of product and to determine the suitability of the product for its intended use. We do not accept responsibility for any loss or damage which may occur from the use of this information.